

Mountain Bluff Collection

Essential Adirondack Side Table

Assembly Guide

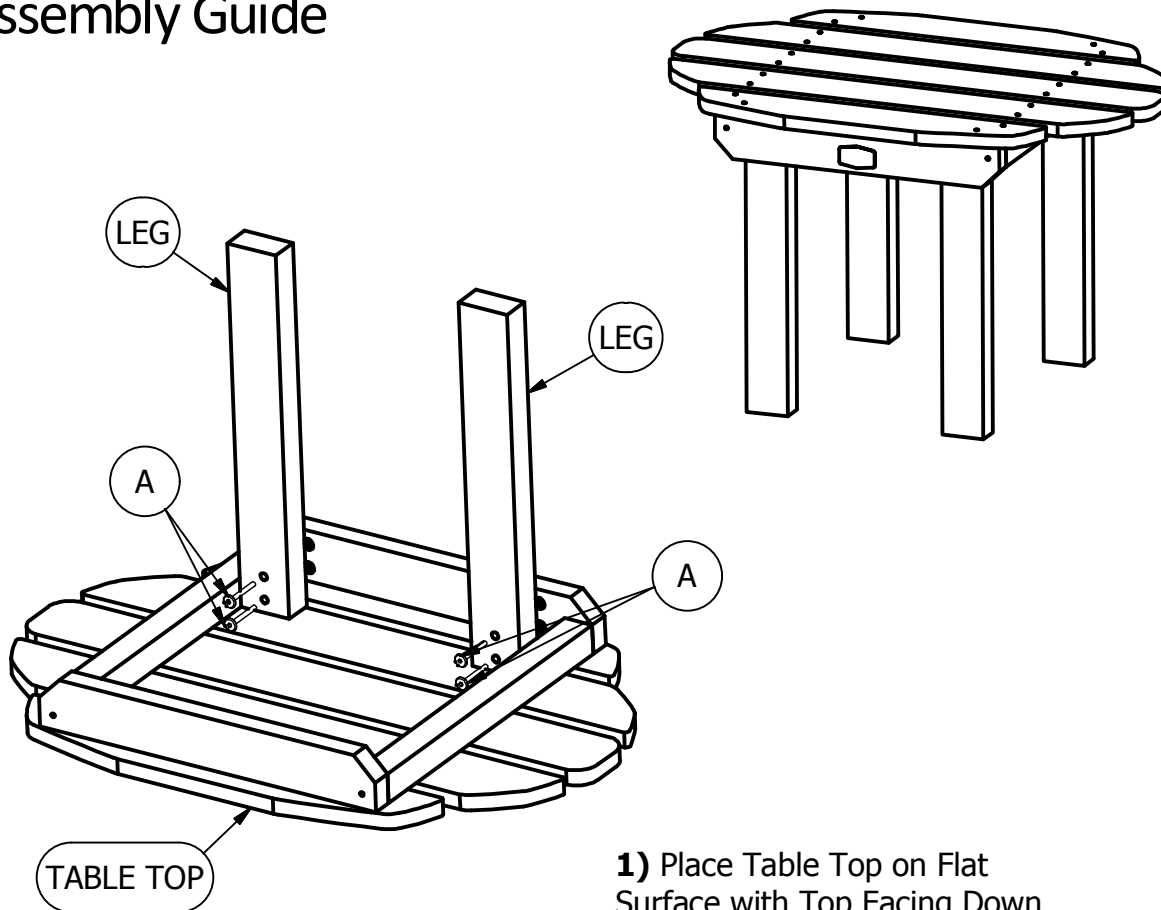

1) Place Table Top on Flat Surface with Top Facing Down As Shown.

2) Attach Legs to One Side of Table Using (2) "A" Bolts in Each Leg as Shown.

3) Repeat Step 2 on Other Side of Table.

HARDWARE

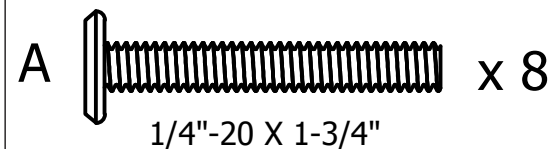

IMPORTANT!

DO NOT fully tighten the bolts until all bolts are started. Once all bolts are inserted, go back & tighten all the bolts.

Retain these instructions for future reference

INCLUDED TOOLS

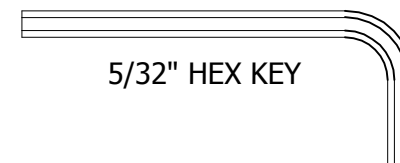

ELK OUTDOORS
by **highwood**[®]

For information on Care and Cleaning or to register your ELK OUTDOORS product by *highwood*[®], please visit www.highwood-usa.com.

TBL-CW2
02.26.18

PAGE 1 OF 1