

Weatherly Garden Chair

Assembly Guide

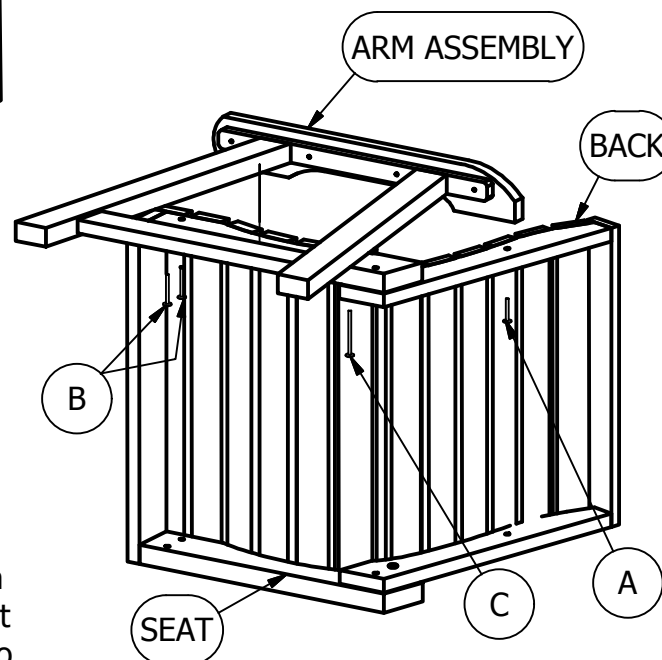
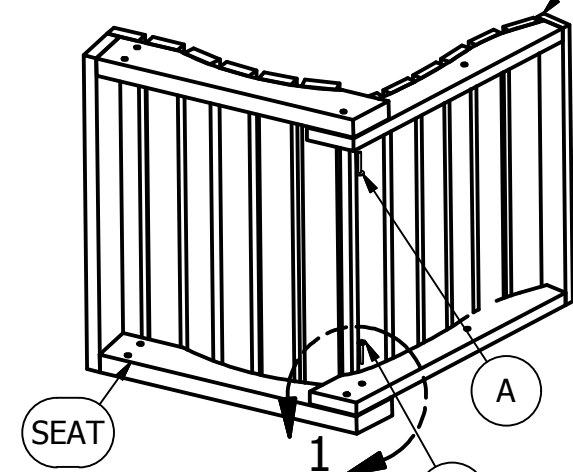
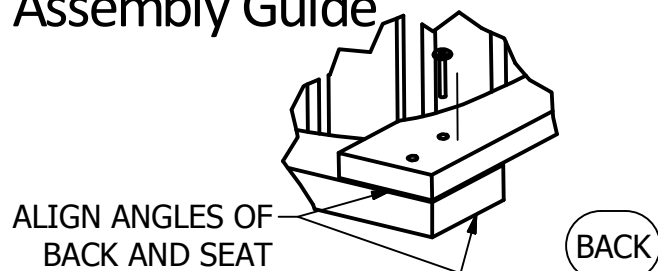

1) Attach Chair Back to Seat Using One "A" Bolt in the Upper Hole on Each Side.

2) Attach Leg Assembly to Seat Using Two "B" Bolts in Front and One "C" Bolt in Rear. Attach Arm to Back Using One "A" Bolt.

3) Repeat on Other Side.

HARDWARE

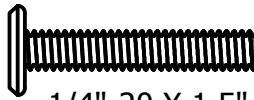
A  x4
1/4"-20 X 1.5"

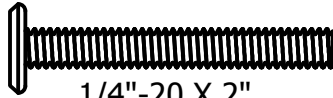
B  x4
1/4"-20 X 2"

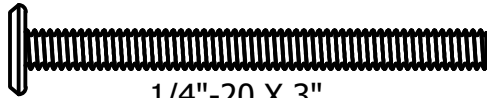
C  x2
1/4"-20 X 3"

IMPORTANT!

DO NOT fully tighten the bolts until all bolts are started. Once all bolts are inserted, go back & tighten all the bolts.

Retain these instructions for future reference

INCLUDED TOOLS

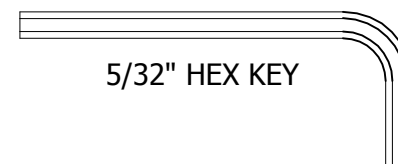

5/32" HEX KEY