

# Lehigh Collection Dining Chair

## Assembly Guide

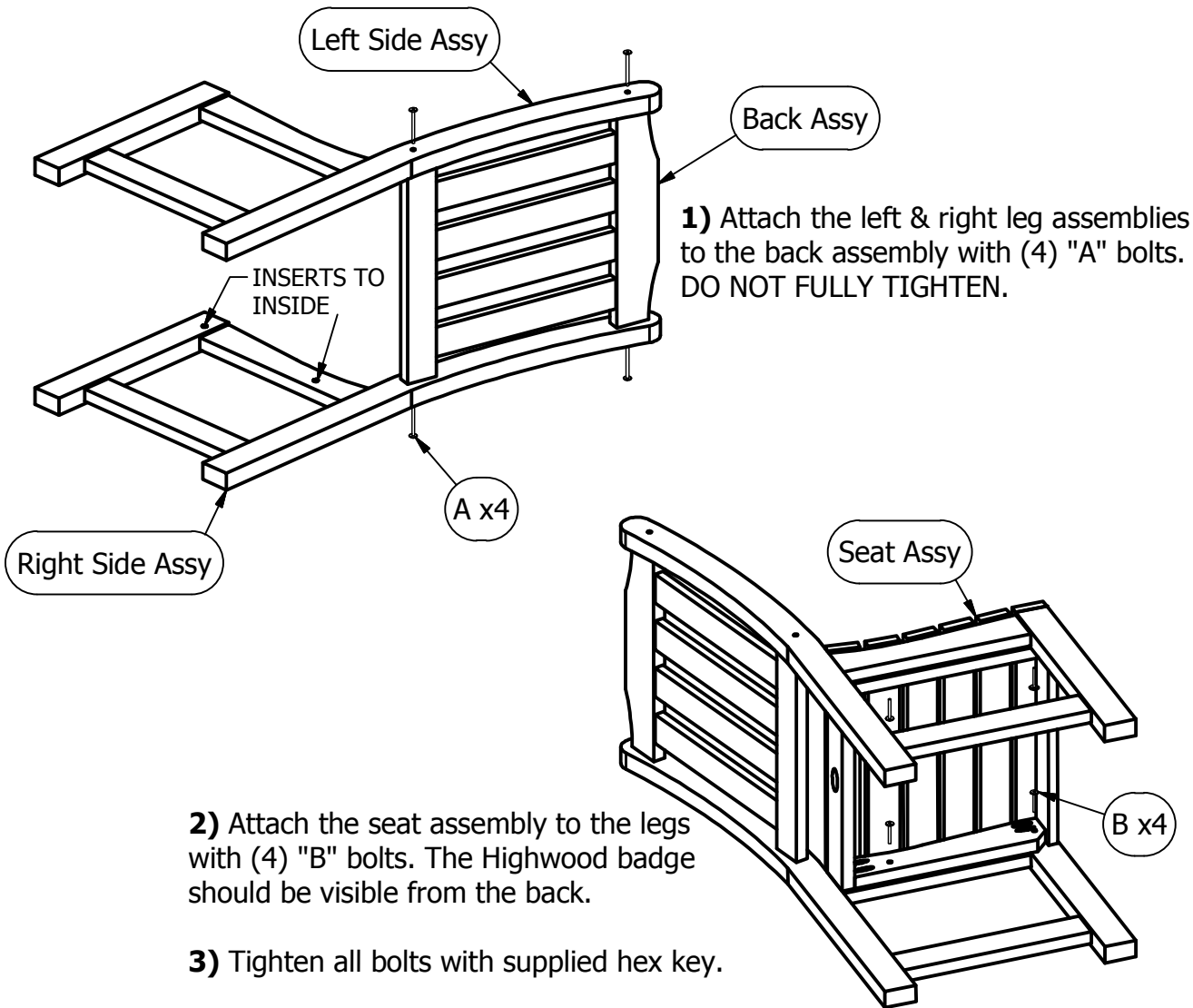

### HARDWARE

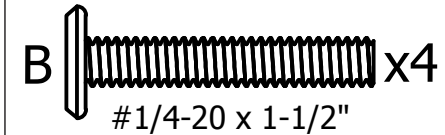
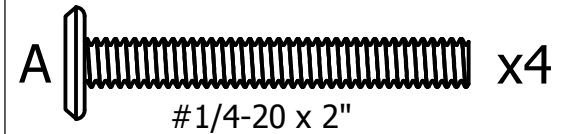

### IMPORTANT!

DO NOT fully tighten the bolts until all bolts are started. Once all bolts are inserted, go back & tighten all the bolts.

Retain these instructions for future reference

### INCLUDED TOOLS

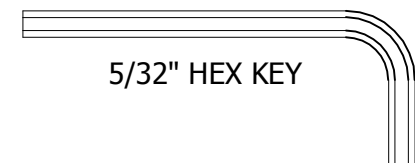

# Lehigh Collection Counter Chair

## Assembly Guide

**1)** Attach the legs to the back and cross bars with (8) "A" bolts.  
DO NOT FULLY TIGHTEN THE BOLTS.

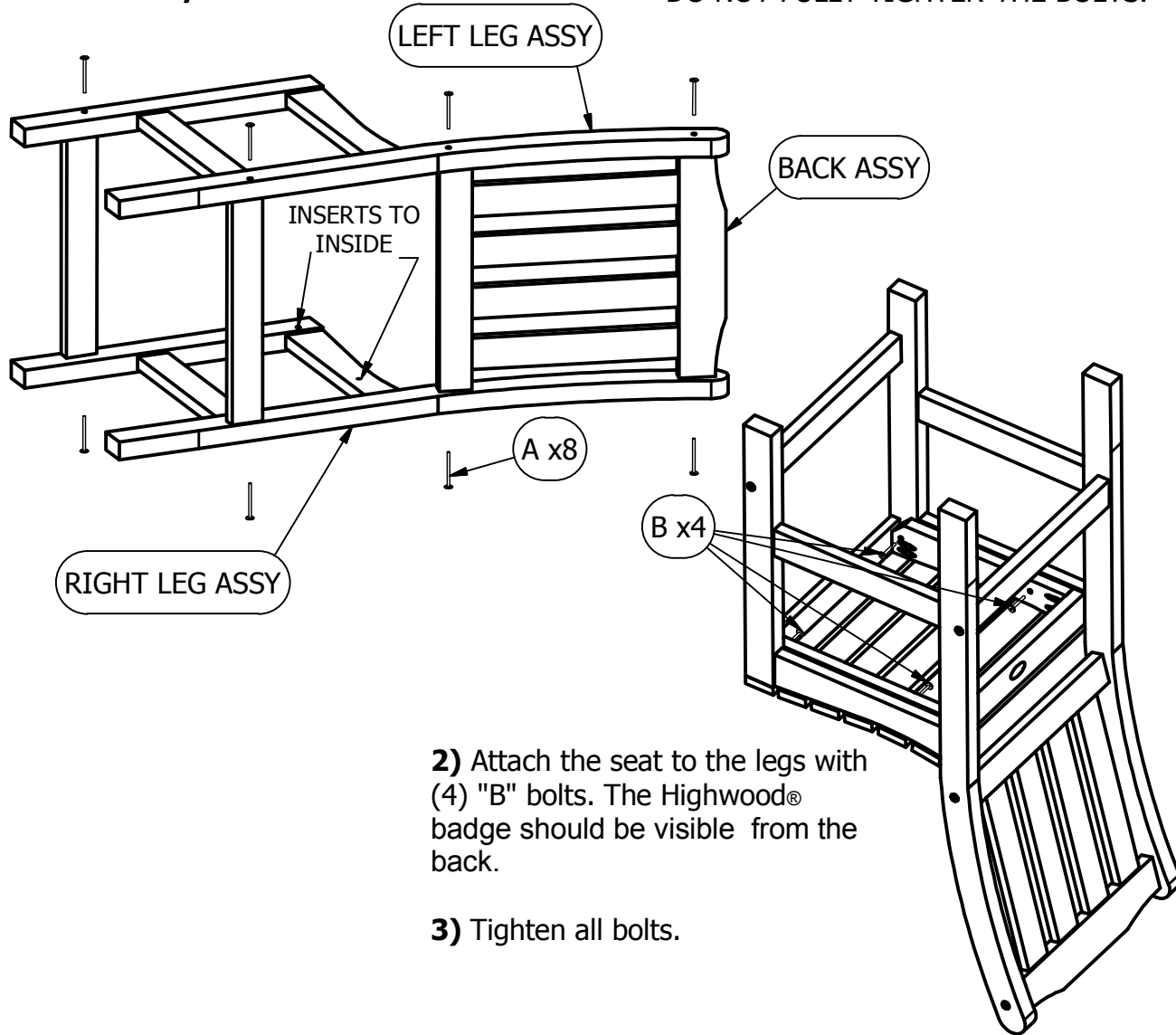

**2)** Attach the seat to the legs with (4) "B" bolts. The Highwood® badge should be visible from the back.

**3)** Tighten all bolts.

### HARDWARE

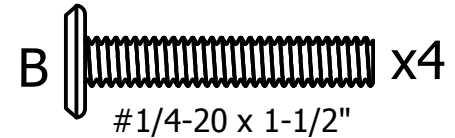
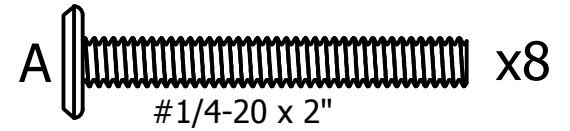

### IMPORTANT!

DO NOT fully tighten the bolts until all bolts are started. Once all bolts are inserted, go back & tighten all the bolts.

Retain these instructions for future reference

### INCLUDED TOOLS

